



WELLMATE[®] COMPOSITE PRESSURE TANKS

FILTRATION & PROCESSING SOLUTIONS

PENTAIR® WELLMATE® OFFERS DEALERS MORE ADVANTAGES, MORE SOLUTIONS FOR MORE APPLICATIONS.

A GROWING CUSTOMER BASE.

In the residential, commercial, and agricultural markets of the world, Pentair Wellmate composite tanks have long been the tank of choice for their unmatched performance over steel. As the recognized leader in composite pressure tank design, Pentair Wellmate Water Systems give you more to sell.

With unique features that translate into real benefits for your customers, Wellmate by Pentair sets you apart from the competition.

A MATERIAL DIFFERENCE.

From the high-density polyethylene inner liner, to the fiberglass-wound and epoxy resin-sealed outer shell, Pentair Wellmate tanks do not contain steel, so they will not rust. What they can do is make everything easier. Wellmate Tanks by Pentair require little or no maintenance because they won't dent and they do not have paint to scratch and touch

up. Their light weight – half that of steel tanks – makes them easier and faster to install. In fact, most can be handled by a single installer, keeping costs down. Pentair Wellmate Tanks are certified to CE and NSF/ANSI std. 61 section 8 and Annex G and are 100% lead-free. In addition, they will not introduce undesirable chemicals or elements into the water.

A PRODUCT THAT'S WORTH MORE.

Innovative Pentair Wellmate solutions for water storage and pressure boosting applications offer you a world class product that's worth more. From initial design through promised delivery, quality is a hallmark of Wellmate by Pentair Tanks. State-of-the-art equipment, the best materials and an ISO-9001 certified manufacturing facility guarantee that our one-piece composite construction is second to none.

ONGOING DEALER SUPPORT.

As a Pentair Wellmate dealer, you'll enjoy total dealer support. Wellmate Tanks by Pentair are only sold through a network of select professional dealers, giving you a real opportunity to make your mark. In addition, Pentair Wellmate dealers enjoy the benefits of sales training programs, seminars and technical support, as well as marketing support and dealer incentive programs. Want to know more about Wellmate by Pentair and the edge it gives its dealers? Call your Pentair Wellmate distributor or visit www.wellmate.com for more information.



TABLE OF CONTENTS

2-3	LOW-PROFILE™ SERIES
4-5	WM™-SERIES
6-7	UT™-QUICK CONNECT SERIES
8-9	HP-QUICK CONNECT SERIES
10-11	E-SERIES™
12	UNIVERSAL/HP AERATION TANKS
13	RESIDENTIAL TANK REPLACEMENT GUIDE

LP-SERIES (QUICK CONNECT AND STANDARD MODELS)

LOW-PROFILE CAPTIVE AIR TANKS

BIG ON PERFORMANCE, SMALL ON SPACE.

Designed for height-restricted applications such as mobile homes, crawl spaces and closets, our compact LP-Series pressure tanks give you added flexibility in small-space residential applications. Plus they offer you these distinct advantages:

- Highest Drawdown in the Industry for its Profile.
- Air Cell – easier to service in the field.
- Quick Change Connection – easier to install.
- Lightweight – easier to maneuver.
- Available in two styles:
 - QUICK CONNECT drain assembly, butyl air cell.
 - CLASSIC drain assembly, polyether urethane (PEU) air cell.



APPLICATIONS

- Mobile Homes
- Crawl Spaces
- Closets



QUICK CONNECT



CLASSIC



HERE ARE THE FEATURES THAT SET US APART

- 1A** Heavy-gauge, butyl air cell is chlorine-resistant and fully replaceable.
- 1B** Durable, polyether urethane (PEU) air cell is fully replaceable.
- 2** One-piece seamless inner shell is molded of high-density polyethylene.
- 3** Outer shell is composed of continuous fiberglass strands sealed with high-grade epoxy resin.
- 4** Sturdy, molded polymeric base is corrosion and impact proof.
- 5A** Quick connect, bottom inlet/outlet assembly is custom molded of high-impact engineered polymer.
- 5B** Bottom inlet/outlet assembly is custom molded of high-impact PVC.

SPECIFICATIONS – QUICK CONNECT

MODEL	CAPACITY GAL / LITER	MAXIMUM OPERATING PRESSURE PSI / kPa / BAR	DRAWDOWN 30/50 SETTING** GAL/LITER	DIAMETER* INCH / CM	OVERALL HEIGHT* INCH / CM	HEIGHT* INLET/OUTLET TO FLOOR INCH / CM	SYSTEM CONNECTION	ASSEMBLY WEIGHT* LB / KG
WM-6LP / WM-LP-075 QC	19.3 / 73	125 / 862 / 8.6	6.0 / 22.7	24 / 61	21 / 53	2.25 / 5.7	1" male NPT	25.2 / 11.4
WM-10LP / WM-LP-130 QC	34.5 / 131	125 / 862 / 8.6	10.7 / 40.5	24 / 61	29.8 / 75.7	2.25 / 5.7	1" male NPT	32.85 / 14.9

SPECIFICATIONS – CLASSIC

MODEL	CAPACITY GAL / LITER	MAXIMUM OPERATING PRESSURE PSI / kPa / BAR	DRAWDOWN 30/50 SETTING** GAL/LITER	DIAMETER* INCH / CM	OVERALL HEIGHT* INCH / CM	HEIGHT* INLET/OUTLET TO FLOOR INCH / CM	SYSTEM CONNECTION	ASSEMBLY WEIGHT* LB / KG
WM-6LP / WM-LP-075	19.3 / 73	125 / 862 / 8.6	5.8 / 21.9	24 / 61	20.25 / 51	2.25 / 5.7	1" male NPT	22.75 / 10.3
WM-10LP / WM-LP-130	34.5 / 131	125 / 862 / 8.6	10.4 / 39.2	24 / 61	28 / 71	2.25 / 5.7	1" male NPT	29.5 / 13.4

NOTE: Maximum external operating temperature 120°F [49°C]. Maximum internal operating temperature 100°F [38°C]. Minimum operating temperature 40°F [4°C].

* Diameter, height and weight may vary slightly without notice.

** In keeping with current industry standards, drawdown factors are based on Boyle's law. Actual drawdowns will vary depending upon system variables, including the accuracy and operation of the pressure switch and gauge and operating temperature of the system.

WM-SERIES (QUICK CONNECT AND CLASSIC MODELS)

CAPTIVE AIR TANKS

EASY TO INSTALL, MAINTAIN, AND SERVICE.

Our WM-Series offers features and benefits that steel tanks just can't match. From their corrosion-proof composite construction to their lighter weight, easier maintenance and less expensive installation, WM-Series pressure tanks are the preferred choice of professionals, especially when the following advantages are added to the mix:

- Available in two styles:
 - QUICK CONNECT drain assembly, butyl air cell.
 - CLASSIC drain assembly, polyether urethane (PEU) air cell.
- Replaceable Air Cell - for easier field servicing.
- Easy to carry.
- Easy and Less Costly to Install - usually requiring only one person and fewer man-hours.
- Greater Drawdown than Comparably-Sized Steel Tanks - for greater efficiency.
- Won't Rust in Corrosive Environments - particularly important in agricultural and livestock applications, and coastal regions.



APPLICATIONS

- Residential
- Light Commercial
- Pressure Boosting

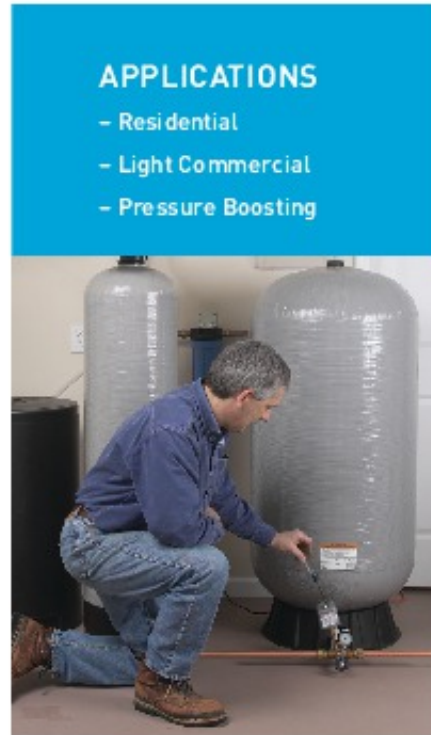

HERE ARE THE FEATURES THAT SET US APART

- 1A Heavy-gauge, butyl air cell is chlorine-resistant and fully replaceable.
- 1B Durable, polyether urethane (PEU) air cell is fully replaceable.
- 2 One-piece seamless inner shell is molded of high-density polyethylene.
- 3 Outer shell is composed of continuous fiberglass strands sealed with high-grade epoxy resin.
- 4 Sturdy, molded polymeric base is corrosion- and impact-proof.
- 5A Quick connect, bottom inlet/outlet assembly is custom molded of high-impact engineered polymer.
- 5B Bottom inlet/outlet one-piece drain is custom molded of high-impact PVC.

QUICK CONNECT



Quick Connect Drain Fitting

CLASSIC

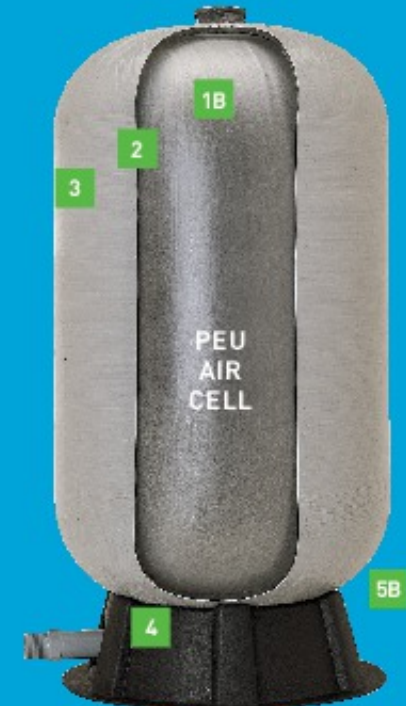

CPVC Drain Assembly (threaded)

SPECIFICATIONS - QUICK CONNECT

MODEL	CAPACITY GAL / LITER	MAXIMUM OPERATING PRESSURE PSI / kPa / BAR	DRAWDOWN 30/50 SETTING** GAL/LITER	DIAMETER* INCH / CM	OVERALL HEIGHT* INCH / CM	HEIGHT* INLET/OUTLET TO FLOOR INCH / CM	SYSTEM CONNECTION	ASSEMBLY WEIGHT* LB / KG
WM-4 / WM0060 QC	14.5 / 55	125 / 862 / 8.6	4.5 / 17.0	16 / 41	27.5 / 70	1.75 / 4.4	1" male NPT	16.9 / 7.6
WM-6 / WM0075 QC	19.8 / 75	125 / 862 / 8.6	6.1 / 23.0	16 / 41	32.5 / 82.5	1.75 / 4.4	1" male NPT	20.85 / 9.5
WM-9 / WM0120 QC	29.5 / 112	125 / 862 / 8.6	9.1 / 34.4	16 / 41	44.5 / 113	1.75 / 4.4	1" male NPT	28.80 / 13.0
WM-11 / WM0130 QC	35 / 132	125 / 860 / 8.6	10.6 / 40.1	21 / 53	33 / 83.8	2.25 / 5.7	1 1/4" male NPT	32 / 14.5
WM-12 / WM0150 QC	40.3 / 153	125 / 862 / 8.6	12.5 / 47.3	16 / 41	57.6 / 146.3	1.75 / 4.4	1" male NPT	35.05 / 15.9
WM-23 / WM0300 QC	79.6 / 301	125 / 862 / 8.6	24.6 / 93.1	21 / 53	62.8 / 159.5	2.25 / 5.7	1 1/4" male NPT	71.07 / 32.3
WM-14WB / WM0180 QC	47.1 / 178	125 / 862 / 8.6	14.6 / 55.2	21 / 53	42 / 106.7	2.25 / 5.7	1 1/4" male NPT	46.27 / 21.0
WM-20WB / WM0235 QC	60.0 / 227	125 / 862 / 8.6	18.5 / 70.0	24 / 61	42.3 / 107.3	2.25 / 5.7	1 1/4" male NPT	52.87 / 24.0
WM-25WB / WM0330 QC	86.7 / 328	125 / 862 / 8.6	26.8 / 101.4	24 / 61	56 / 142.3	2.25 / 5.7	1 1/4" male NPT	77.22 / 35.0
WM-35WB / WM0450 QC	119.7 / 453	125 / 862 / 8.6	37.0 / 140.0	24 / 61	75 / 190	2.25 / 5.7	1 1/4" male NPT	102 / 46.4

NOTE: Maximum external operating temperature 120°F (49°C). Maximum internal operating temperature 100°F (38°C). Minimum operating temperature 40°F (4°C).
 * Diameter, height and weight may vary slightly without notice.
 ** In keeping with current industry standards, drawdown factors are based on Boyle's law. Actual drawdowns will vary depending upon system variables, including the accuracy and operation of the pressure switch and gauge and operating temperature of the system.

SPECIFICATIONS - CLASSIC

MODEL	CAPACITY GAL / LITER	MAXIMUM OPERATING PRESSURE PSI / kPa / BAR	DRAWDOWN 30/50 SETTING** GAL/LITER	DIAMETER* INCH / CM	OVERALL HEIGHT* INCH / CM	HEIGHT* INLET/OUTLET TO FLOOR INCH / CM	SYSTEM CONNECTION	ASSEMBLY WEIGHT* LB / KG
WM-4 / WM0060	14.5 / 55	125 / 862 / 8.6	4.4 / 16.5	16 / 41	26 / 66	1.75 / 4.4	1" male NPT	14.5 / 6.6
WM-6 / WM0075	19.8 / 75	125 / 862 / 8.6	5.9 / 22.5	16 / 41	32 / 81	1.75 / 4.4	1" male NPT	17.75 / 8.1
WM-9 / WM0120	29.5 / 112	125 / 862 / 8.6	8.9 / 33.5	16 / 41	44 / 112	1.75 / 4.4	1" male NPT	24.75 / 11.2
WM-12 / WM0150	40.3 / 153	125 / 862 / 8.6	23.8 / 90.4	21 / 53	62 / 157	2.25 / 5.7	1 1/4" male NPT	65.7 / 29.8
WM-23 / WM0300	79.6 / 301	125 / 862 / 8.6	14.1 / 53.5	21 / 53	41.25 / 105	2.25 / 5.7	1 1/4" male NPT	43 / 19.5
WM-14WB / WM0180	47.1 / 178	125 / 862 / 8.6	18.0 / 68.1	24 / 61	41.5 / 105	2.25 / 5.7	1 1/4" male NPT	50 / 22.7
WM-20WB / WM0235	60.0 / 227	125 / 862 / 8.6	26.0 / 98.5	24 / 61	55.25 / 140	2.25 / 5.7	1 1/4" male NPT	72.75 / 33.0
WM-35WB / WM0450	119.7 / 453	125 / 862 / 8.6	35.9 / 135.9	24 / 61	74.25 / 189	2.25 / 5.7	1 1/4" male NPT	95 / 43.1

NOTE: Maximum external operating temperature 120°F (49°C). Maximum internal operating temperature 100°F (38°C). Minimum operating temperature 40°F (4°C).
 * Diameter, height and weight may vary slightly without notice.
 ** In keeping with current industry standards, drawdown factors are based on Boyle's law. Actual drawdowns will vary depending upon system variables, including the accuracy and operation of the pressure switch and gauge and operating temperature of the system.

UT™-SERIES

UNIVERSAL RETENTION TANKS

DO YOU HAVE CONTACT WITH CHEMICALS, CHLORINE, HYDROGEN SULFIDE? GO WITH THE PROS AND CHOOSE UT.

There's no better tank choice for water treatment than our UT-Quick Connect Series. Composite construction makes the entire line impervious to the chemicals found in aggressive water. Plus the following advantages give our UT-Quick Connect Series the kind of application versatility dealers want:

- Inlet/Outlet PVC Pipe Connections – allow straight through T connection on bottom of tank for ease of piping.
- Blowdown Valve – for easy removal of sludge from bottom of tank.
- Hydropneumatic Convertible – optional air volume control assembly and micronizer allow for quick and easy tank conversion. Dealers no longer need to stock more than one kind of air-over-water pressure tank.



APPLICATIONS

– Contact Tank for Water Treatment

– Hydropneumatic
[with purchased accessories]

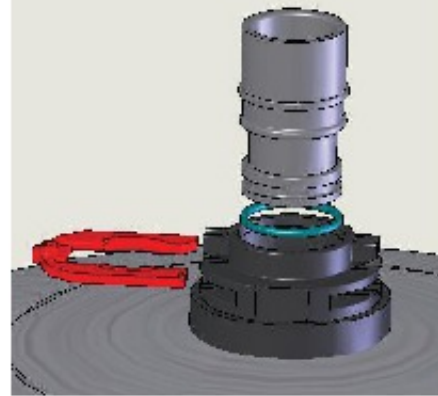

HERE ARE THE FEATURES THAT SET US APART

- 1 Vacuum breaker required.
- 2 Standard 1" ID / 1/4" Quick Connect Socket.
- 3 One piece, seamless inner shell molded of premium, high-density polyethylene which provides impact and corrosion resistance.
- 4 Miles of fiberglass filament covered with epoxy resin produce superior strength in a light-weight design.
- 5 Additional drain port.
- 6 Curved bottom dome design maximizes contact time and facilitates sludge removal.

1 1/4" socket inlet/outlet PVC pipe connections offer maximum application flexibility.



SPECIFICATIONS

QUICK CONNECT MODEL	CAPACITY GAL / LITER	MAXIMUM OPERATING PRESSURE PSI / kPa / BAR	DIAMETER* INCH / CM	OVERALL HEIGHT* INCH / CM	HEIGHT* INLET/OUTLET TO FLOOR INCH / CM	SYSTEM CONNECTION		ASSEMBLY WEIGHT* LB / KG
						TOP	BOTTOM	
UT-30 / WM-UT-110 / CE	30 / 114	75 / 500 / 5.0	16 / 41	44.5 / 113	1.5 / 3.8	1 1/4" Socket Q.C.	1 1/4" Socket	25 / 11.3
UT-40 / WM-UT-150 / CE	40 / 151	75 / 500 / 5.0	16 / 41	57.25 / 145	1.5 / 3.8	1 1/4" Socket Q.C.	1 1/4" Socket	28 / 12.7
UT-40SQ / WM-UT-150-SQ / CE	40 / 151	75 / 500 / 5.0	21 / 53	36 / 91	2 / 5.1	1 1/4" Socket Q.C.	1 1/4" Socket	33 / 15.0
UT-80 / WM-UT-300 / CE	80 / 303	75 / 500 / 5.0	21 / 53	62.75 / 159	2 / 5.1	1 1/4" Socket Q.C.	1 1/4" Socket	43 / 19.5
UT-120 / WM-UT-450 / CE	120 / 454	75 / 500 / 5.0	24 / 61	72.25 / 186	2 / 5.1	1 1/4" Socket Q.C.	1 1/4" Socket	63 / 28.6

NOTE: Maximum external operating temperature 120°F [49°C]. Maximum internal operating temperature 100°F [38°C]. Minimum operating temperature 40°F [4°C].

*Diameter, height and weight may vary slightly without notice.



ACCESSORIES

[For Hydropneumatic Conversion]

(Consult factory for correct size)	Air Volume Control Assembly
Part #CH3929-5	Micronizer
Part #CH19426	Vacuum Breaker 1/8" NPT



NOTE: Flexible connectors must be installed between hard piping and tank openings. These pressure vessels are rated for an internal negative pressure of 5" HG [17 Pa] vacuum below atmospheric. If negative pressure could ever exceed 5" Hg [17 Pa], an adequate vacuum breaker must also be properly installed. Failure to install flex connection properly, or improper installation of a vacuum breaker when required, may void the warranty.

HP™-SERIES

HYDRO-PNEUMATIC AIR/WATER TANKS

THE TOUGHEST TANKS FOR YOUR MOST DIFFICULT INSTALLS.

Iron and sulfur removal? Methane and other undesirable well gases? You need our HP-Quick Connect Series of hydro-pneumatic tanks. These high performance tanks can be used for aggressive water, or as an open system where air is introduced to oxidize and aerate. All this, plus these other key advantages:

- Large Drawdown Ratio – for increased efficiency.

- Adapter and UT Drain Assembly – (sold separately) – allows you to add 1" riser pipe to increase aeration of water. See page 12.
- Self-Adjusting Air Volume Control – for system flexibility and ease of installation.



APPLICATIONS

- Sulfur and Iron Water Treatment
- Hypochloride Environments
- Release of Methane or Other Well Gases



HERE ARE THE FEATURES THAT SET US APART

- 1 1/4" vent line, 360° rotating threadless connection.
- 2 Top-mounted air volume control provides 50% or more drawdown than similar sized conventional tanks.
- 3 Miles of fiberglass filament covered with epoxy resin produce superior strength in a light-weight design.
- 4 Self-adjusting air volume control – a Pentair® Wellmate® exclusive.
- 5 One piece, seamless inner shell molded of premium, high-density polyethylene which provides impact and corrosion resistance.
- 6 Convex bottom design with top-mounted air volume control maximizes drawdown.
- 7 1 1/4" socket inlet/outlet PVC pipe connections offer maximum application flexibility.
- 8 Blowdown port with 1/2" NPT connection.

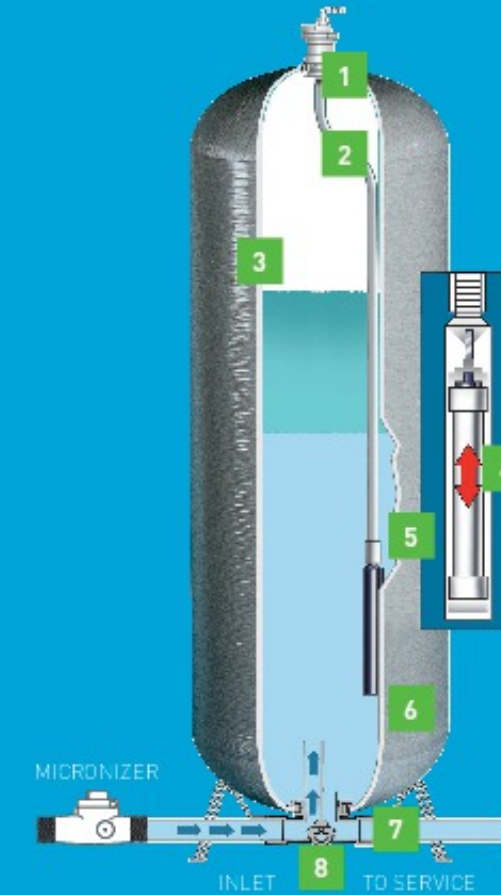

SPECIFICATIONS

QUICK CONNECT MODEL	CAPACITY GAL / LITER	MAXIMUM OPERATING PRESSURE PSI / kPa / BAR	DRAWDOWN 30/50 SETT IN G** GAL/LITER	DIAMETER* INCH / CM	OVERALL HEIGHT* INCH / CM	HEIGHT* INLET/OUTLET TO FLOOR INCH / CM	SYSTEM CONNECTION		ASSEMBLY WEIGHT* LB / KG
							TOP	BOTTOM	
HP-7/WM-HP-110	30 / 114	75 / 500 / 50	6.6 / 25.0	16 / 41	43.75 / 111	1.5 / 3.8	1 1/4" vent line	1 1/4" Socket	26 / 11.8
HP-9/WM-HP-150	40 / 151	75 / 500 / 50	9.0 / 34.1	16 / 41	56.5 / 144	1.5 / 3.8	1 1/4" vent line	1 1/4" Socket	29 / 13.2
HP-85Q/WM-HP-150SQ	40 / 151	75 / 500 / 50	8.0 / 30.3	21 / 53	35.25 / 90	2 / 5.1	1 1/4" vent line	1 1/4" Socket	34 / 15.4
HP-18/WM-HP-300	80 / 303	75 / 500 / 50	17.8 / 67.4	21 / 53	62 / 157	2 / 5.1	1 1/4" vent line	1 1/4" Socket	44 / 20.0
HP-26/WM-HP-450	120 / 454	75 / 500 / 50	25.5 / 96.5	24 / 61	72.5 / 184	2 / 5.1	1 1/4" vent line	1 1/4" Socket	64 / 29.0

NOTE: Maximum external operating temperature 120°F [49°C]. Maximum internal operating temperature 100°F [38°C]. Minimum operating temperature 40°F [4°C].

* Diameter, height and weight may vary slightly without notice.

** In keeping with current industry standards, drawdown factors are based on Boyle's law. Actual drawdowns will vary depending upon system variables, including the accuracy and operation of the pressure switch and gauge and operating temperature of the system.

ACCESSORIES

Part #CH3929-5	Micronizer
Part #CH19426	Vacuum Breaker 1/4" NPT



NOTE: Flexible connectors must be installed between hard piping and tank openings. These pressure vessels are rated for an internal negative pressure of 5" HG [17 Pa] vacuum below atmospheric. If negative pressure could ever exceed 5" Hg [17 Pa], an adequate vacuum breaker must also be properly installed. Failure to install flex connection properly, or improper installation of a vacuum breaker when required, may void the warranty.

E-SERIES

CAPTIVE AIR AND RETENTION TANKS

MAXIMUM STORAGE. MINIMUM HEADACHES.

Wider pressure switch settings on our E-Series tanks allow for maximum water storage during periods of peak demand. As a captive air tank, the E-Series can handle up to 125 psi/8.6 bar operating pressure. Plus the high-volume, high-pressure tanks offer these benefits:

- Retention Tank Capability – without the air cell, can function as a high capacity retention tank for water storage and treatment.

- Polyether Urethane (PEU) Air Cell – offers a longer life than bladders or diaphragms.
- Wider Range of Pressure Settings – for greater application versatility.
- Pre-Installed Inlet/Outlet Assembly – with system connections to save time and money.



APPLICATIONS

- High Volume Water Storage
- Water Storage Treatment



HERE ARE THE FEATURES THAT SET US APART

- 1 Air cell** – polyether urethane (PEU) – captive air tank only.
- 2 Vessel** – fiberglass and epoxy filament wound onto a one-piece molded liner.
- 3 Base** – glass filled sheet molding compound.

CAPTIVE AIR TANK



RETENTION TANK



Our E-Series tanks are also available as a retention tank for water storage/treatment.

SPECIFICATIONS

MODEL	CAPACITY GAL / LITER	MAXIMUM OPERATING PRESSURE PSI / kPa / BAR	DRAWDOWN 30/50 SETTING** GAL/LITER	DIAMETER* INCH / CM	OVERALL HEIGHT* INCH / CM	HEIGHT* INLET/OUTLET TO FLOOR INCH / CM	SYSTEM CONNECTION		ASSEMBLY WEIGHT* LB / KG
							TOP	BOTTOM	
CAPTIVE AIR TANK									
WM-60	187 / 707	125 / 862 / 8.6	55.2 / 209	30 / 76	79 / 201	7.5 / 19	N/A	2" FNPT	234 / 106.14
WM-80	264 / 999	125 / 862 / 8.6	78.0 / 295	36 / 91	81 / 206	8.0 / 20	N/A	2" FNPT	292 / 132.45
RETENTION TANK									
RT-200	187 / 707	125 / 862 / 8.6	N/A	30 / 76	79 / 201	7.5 / 19	2" NPSM	2" MNPT	234 / 106.14
RT-270	264 / 999	125 / 862 / 8.6	N/A	36 / 91	81 / 206	8.0 / 20	2" NPSM	2" MNPT	292 / 132.45

NOTE: Maximum external operating temperature 120°F [49°C]. Maximum internal operating temperature 100°F [38°C]. Minimum operating temperature 40°F [4°C].

* Diameter, height and weight may vary slightly without notice.

** In keeping with current industry standards, drawdown factors are based on Boyle's law. Actual drawdowns will vary depending upon system variables, including the accuracy and operation of the pressure switch and gauge and operating temperature of the system.

AERATION TANKS

HOW TO AIR OUT UNDESIRABLE GASES.

Got a problem with undesirable well gases? These tanks have been designed to introduce air to oxidize and aerate, minimizing or even eliminating both methane gas and hydrogen sulfide gas which is detectable by its rotten egg odor. These tough-performing tanks also offer the following:

- Large Drawdown Ratio – for increased efficiency.
- Self Adjusting Air Volume Control System – for flexibility and ease of installation.
- Composite Construction – for increased tank life.

*Pentair® Wellmate® does not guarantee sizing requirements or the successful removal of odors and gases. It is the responsibility of the contractor or water treatment specialist to assess the many variables involved and select the proper tank.

1 1/4" vent line. 360° rotating threadless connection. Vacuum breaker required.* (Refer to "note" below)

2 Water level.

3 Cap and pipe with 1/4" drilled holes to distribute flow (minimum 12-17 holes required).

4 Riser tube of 1" pipe (customer supplied).

5 Adapter P/N CH11068.

6 Vacuum breaker required for HP applications.

7 Air volume control system.

8 Micronizer.

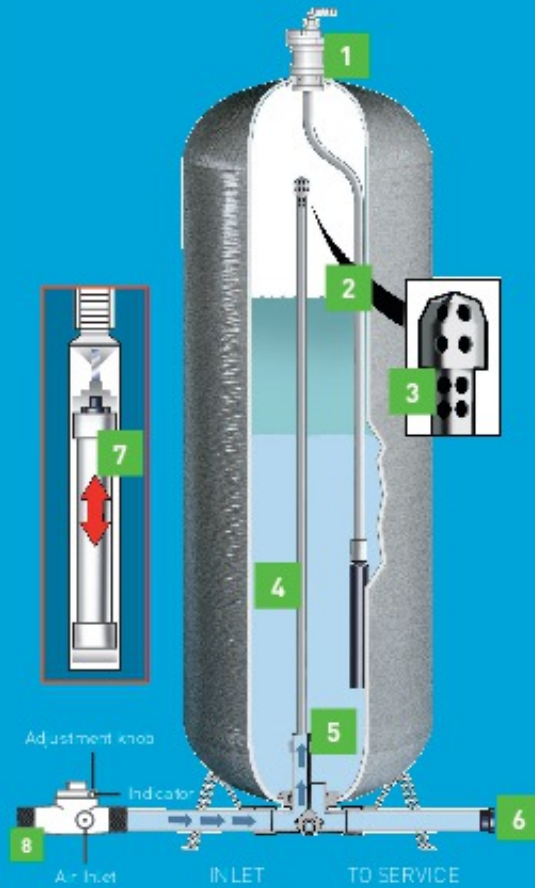

WARNING: To avoid health or environmental hazards from gas accumulation, pump the top fitting to vent off gas to a safe area.

SPECIFICATIONS

QUICK CONNECT MODEL	CAPACITY GAL / LITER	1" RISER TUBE LENGTH (INCHES)	1/2 AVC (TUBE ONLY) (INCHES)	AVC OVER ALL LENGTH (INCHES)
UT-30 / HP-7	30 / 114	26.00	23.25	34.88
UT-40SQ / HP-85Q	40 / 151	16.00	14.50	26.15
UT-40 / HP-9	40 / 151	37.50	35.50	47.12
UT-80 / HP-18	80 / 303	42.75	40.00	51.62
UT-120 / HP-26	120 / 454	53.00	46.50	58.12

ACCESSORIES

Part # CH929-5	Micronizer
Part # CH19426	Vacuum Breaker 1/4" NPT
Part # CH11068	Adapter



Micronizer Vacuum Breaker

NOTE: Maximum external operating temperature 120°F [49°C]. Maximum internal operating temperature 100°F [38°C]. Minimum operating temperature 40°F [4°C].

Diameter, height and weight may vary slightly without notice.

In keeping with current industry standards, drawdown factors are based on Boyle's law. Actual drawdowns will vary depending upon system variables, including the accuracy and operation of the pressure switch and gauge and operating temperature of the system.

NOTE: Flexible connectors must be installed between hard piping and tank openings. These pressure vessels are rated for an internal negative pressure of 5" HG [17 Pa] vacuum below atmospheric. If negative pressure could ever exceed 5" Hg [17 Pa], an adequate vacuum breaker must also be properly installed. Failure to install flex connection properly, or improper installation of a vacuum breaker when required, may void the warranty.

RESIDENTIAL TANK REPLACEMENT GUIDE

PENTAIR® WELLMATE®	WM-01	WM-02	WM-4 / WM0050QC	WM-6LP / WM-LP-075QC	WM-6 / WM0075QC	WM-9 / WM0120QC	WM-10LP / WM-LP-130QC	WM-11 / WM0130QC	WM-12 / WM0150QC	WM-14WB / WM0180QC	WM-20WB / WM0235QC	WM-23 / WM0300QC	WM-25WB / WM0330QC	WM-35WB / WM0450QC
Gallons	2	5	14	19	20	30	34	35	40	47	60	80	87	119
Champion Amtrol	CH1001	CH1002	CH3001	n/a	CH4202	CH8205	n/a	n/a	CH8205	CH10050	CH12051	n/a	CH17255	CH22050
ProLine Amtrol	CA1001	CA3002	CA3001	n/a	CA4202	CA8205	n/a	n/a	CA10050	CA10050	CA12051	n/a	CA17002	CA22050
Well-Flow Amtrol	WF-6	WF-15	WF-45	n/a	WF60	WF100	n/a	n/a	n/a	WF140	WF200	n/a	WF260	WF360
Well-Trol Amtrol	WX-101	WX-102	WX-201	n/a	WX-202	WX-205	n/a	n/a	WX-250	WX-250	WX-251	n/a	WX-255	WX-350
Clayton Mark	CM1001	CM1002	CM-200	n/a	CM-202	CM-203	n/a	n/a	n/a	CM-250	CM-251	n/a	CM-302	CM-350
Etbi	D8	D18	DV50	n/a	DV80	n/a	n/a	n/a	n/a	DV200	n/a	n/a	n/a	DV450
Challenger Flexcon	JR6	JR15	PC64	n/a	PC66	PC111	n/a	n/a	PC122	PC144	PC211	n/a	PC266	PC366
Well-Rite Flexcon	JR6	JR15	WR45	n/a	WR60	WR80	n/a	n/a	WR120	WR140	WR200	n/a	WR260	WR360
Flex-Lite	n/a	n/a	FL-5	n/a	FL-7	n/a	n/a	n/a	FL-12	FL-17	FL-22	FL-28	FL-30	FL-40
Aqua Air Goulds	VBP	V15P	V45	n/a	V60	V100	n/a	n/a	n/a	V140	V200	n/a	V250	V350
Myers	MIL2	MIL5	MPD14	n/a	MPD20	n/a	n/a	n/a	n/a	n/a	n/a	n/a	MPD86	MPD119
ConAire Sta-Rite	CA-9	n/a	n/a	n/a	CA-42	n/a	n/a	n/a	n/a	CA-120	n/a	n/a	CA-220	n/a
Pro Source Fiberwound	n/a	n/a	PSC-4-4	n/a	PSC-20-6	PSC-20-9	n/a	PSC-35-10	PSC-40-12	PSC-48-14	PSC-60-20	PSC-80-23	PSC-85-25	PSC-119-35
Vertical Steel Sta-Rite SR	n/a	n/a	PS30-T01	n/a	PSP42T-T02	PSP75T-T03	n/a	n/a	n/a	PSP120-T50	PSP200-T51	n/a	PSP220-T52	PSP320-TR50
Vertical Steel ProSource	PS2-S01	PS5-S02	PS6-S02	n/a	PS19S-T02	PS32-T03	n/a	n/a	PS35-T05	PS50-T50	PS62-T51	n/a	PS85-T52	PS119-TR50
Vertical Steel ProSource PLUS	n/a	n/a	n/a	n/a	PSP19T-02 PSP19S-T02	PSP32-T03	n/a	n/a	PSP35-T05	PSP50-T50	PSR62-T51	n/a	PSP85-T52	PSP119-TR50
Perma Tank Stato	PIL-2	PIL-5	PAD-14	n/a	PAD-20	n/a	n/a	n/a	n/a	PAD-52	n/a	n/a	PAD-86	PAD-119

TWO OF THE MOST COMMON HYDROPNEUMATIC APPLICATIONS

Tank Sizing Information

There are three factors to consider when selecting the proper size Pentair® Wellmate® for your water system:

- The pump delivery rate in gallons/liters per minute (GPM/LPM).
- The recommended minimum running time of the pump.
- The minimum (cut-in) and maximum (cut-out) system pressure parameters.

Once these factors are known, the following calculations will determine, in most cases, the correct model to meet your specifications.*

CALCULATING DRAWDOWN

- 1) Pump delivery rate _____ GPM/LPM
- 2) Desired minimum pump running time in minutes _____ Minutes
(1 minute, 45 seconds = 1.75 minutes).
- 3) Multiply line #1 by line #2. _____ Gallons/Liters
This is the minimum drawdown or available water volume required.*

CALCULATING TANK SIZE

- 4) Minimum system pressure (cut-in) _____ PSIG/kPa/bar
- 5) Maximum system pressure (cut-out) _____ PSIG/kPa/bar
- 6) Using table #2, find the drawdown factor applicable to lines #4 and #5. _____ Factor
- 7) Divide line #3 by line #6 to determine the minimum total Wellmate volume required. _____ Gallons/Liters
- 8) Refer to the design data and select the Wellmate model with the lowest total capacity that is greater than or equal to line #7. _____ Model

EXAMPLE: An application using an 8 GPM pump with a minimum run time of 1 minute and a 30-50 PSIG system pressure range;

$$\frac{8\text{GPM} \times 1\text{minute}}{30(\text{factor})} = 26.7 \text{ gallon minimum tank capacity}$$

*If a volume of water needed is greater than the amount calculated on line #3, enter that amount on line #3 in place of the calculated volume.

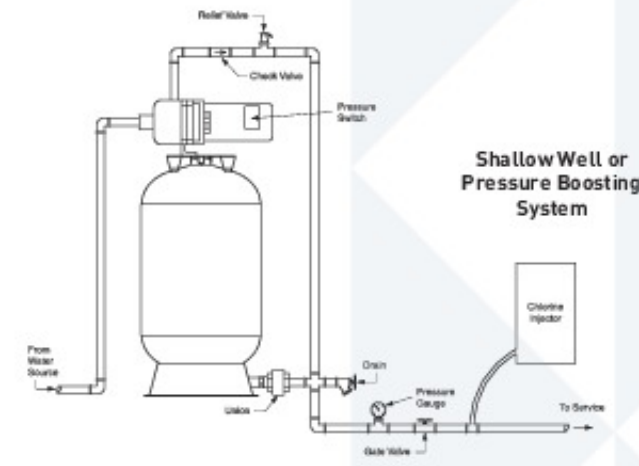

Shallow Well or Pressure Boosting System

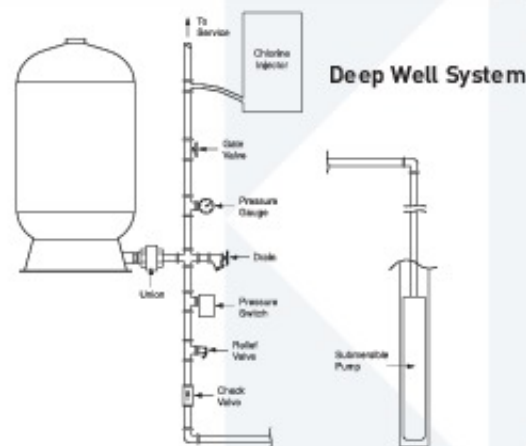

Deep Well System

TABLE #2 - DRAWDOWN FACTORS

MAXIMUM SYSTEM PRESSURE [CUT-OUT] PSIG/[kPa]/bar	MINIMUM SYSTEM PRESSURE [CUT-IN] - PSIG/[kPa]/bar																			
	20 [138]	25 [173]	30 [207]	35 [242]	40 [276]	45 [311]	50 [345]	55 [380]	60 [414]	65 [449]	70 [483]	75 [518]	80 [552]	85 [587]	90 [621]	95 [656]	100 [690]	105 [725]	110 [759]	
30/[207]/2.06	.21																			
35/[242]/2.41	.28	.19																		
40/[276]/2.76	.34	.26	.17																	
45/[311]/3.10	.39	.32	.24	.16																
50/[345]/3.45	.44	.37	.30	.22	.15															
55/[380]/3.80	.47	.41	.34	.28	.21	.14														
60/[414]/4.14	.50	.44	.38	.32	.26	.19	.13													
65/[449]/4.48	.53	.48	.42	.36	.30	.24	.18	.12												
70/[483]/4.83	.56	.50	.45	.40	.34	.29	.23	.17	.11											
75/[518]/5.17		.53	.48	.43	.38	.32	.27	.22	.16	.11										
80/[552]/5.51			.50	.46	.41	.36	.31	.26	.21	.15	.10									
85/[587]/5.86				.48	.43	.39	.34	.29	.24	.20	.15	.10								
90/[621]/6.20					.46	.42	.37	.32	.28	.23	.19	.14	.09							
95/[656]/6.55						.44	.40	.35	.31	.27	.22	.18	.13	.09						
100/[690]/6.89							.42	.38	.34	.30	.26	.21	.17	.13	.09					
105/[725]/7.24								.41	.37	.33	.29	.25	.20	.16	.13	.08				
110/[759]/7.58									.39	.35	.31	.27	.24	.20	.16	.12	.08			
115/[794]/7.92										.38	.34	.30	.26	.23	.19	.15	.11	.08		
120/[828]/8.27											.36	.33	.29	.25	.22	.18	.15	.11	.08	
125/[863]/8.62												.35	.32	.28	.25	.21	.18	.14	.11	.07

In keeping with current industry standards, drawdown factors are based on Boyle's law. Actual drawdowns will vary depending upon system variables, including the accuracy and operation of the pressure switch and gauge, actual precharge pressure, and operating temperature of the system.



WATER PURIFICATION

5730 NORTH GLEN PARK ROAD, MILWAUKEE, WI 53209
262.238.4400, CUSTOMER CARE: 800.279.9404, WWW.PENTAIRAQUA.COM

All Pentair trademarks and logos are owned by Pentair, Inc. All other brand or product names are trademarks or registered marks of their respective owners. Because we are continuously improving our products and services, Pentair reserves the right to change specifications without prior notice.

Pentair is an equal opportunity employer.

WM308 DE12 © 2012 Pentair Residential Filtration, LLC. All Rights Reserved.